

SAFARI 2D

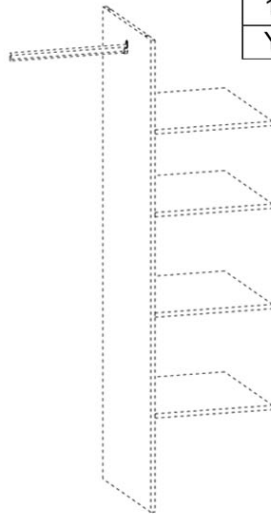

Koda	L, mm	B, mm	H, mm	Q	paket
1	924	575	16	1	1/4
2	924	575	16	1	1/4
4	924	575	16	1	1/4
6	2166	575	16	1	2/4
7	2166	575	16	1	2/4
8	2152	80	25	1	4/4
9	2152	80	25	1	4/4
10	924	55	16	2	1/4
11	396	2028	16	1	3/4
12	396	2028	16	1	3/4
17	959	80	25	1	4/4
18	2104	950	2,5	1	2/4
Y2	918			1	1/4

Pri uporabi pohištva je prepovedano:

- postavljati pohištva v bližino grelnih naprav in ob vlažne stene ter v prostore z relativno vlažnostjo nad 70 %;
- temperatura ogrevanja pohištvenih elementov ne sme presegati + 40 °C;
- med sestavljanjem in uporabo pohištva ne stojte z nogami na vodoravnih ploščah in oknih;
- za čiščenje pohištva ne uporabljajte kemičnih čistilnih sredstev;
- ne sme biti izpostavljeno vodi.

VONJ.

Novo pohištvo lahko oddaja vonj po materialih, iz katerih je izdelano. Vonj se lahko ohrani do tri tedne po namestitvi. Da bi zmanjšali intenzivnost vonja, je priporočljivo, da:

- pri oblaženem pohištvu - izdelek posesajte in prezračite prostor.

Ponovite 3-4-krat na dan.

-pri omarah - obrišite s krpo, navlaženo z blagim detergentom, obrišite s čisto, suho krpo in prezračite prostor ter najprej odprite vsa vrata in predale izdelka.

Ponovite 3-4-krat na dan. Pomembno! Navodila shranite za primer ponovnega sestavljanja pohištva ali reklamacij.

Pri vložitvi reklamacije uporabite oznake, ki so navedene v navodilih.





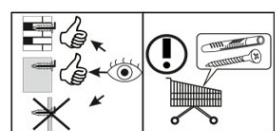
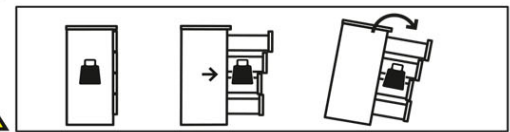

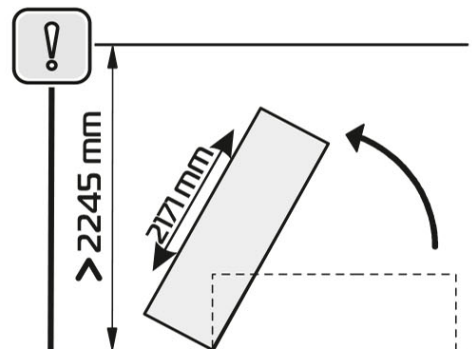
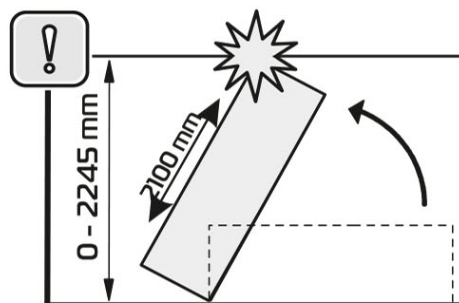
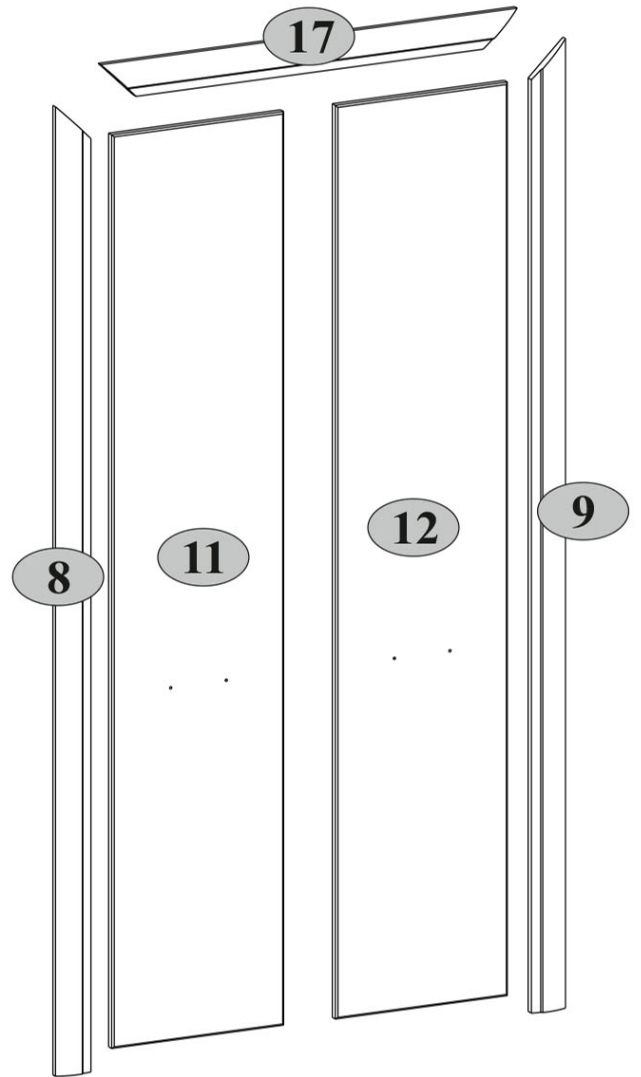
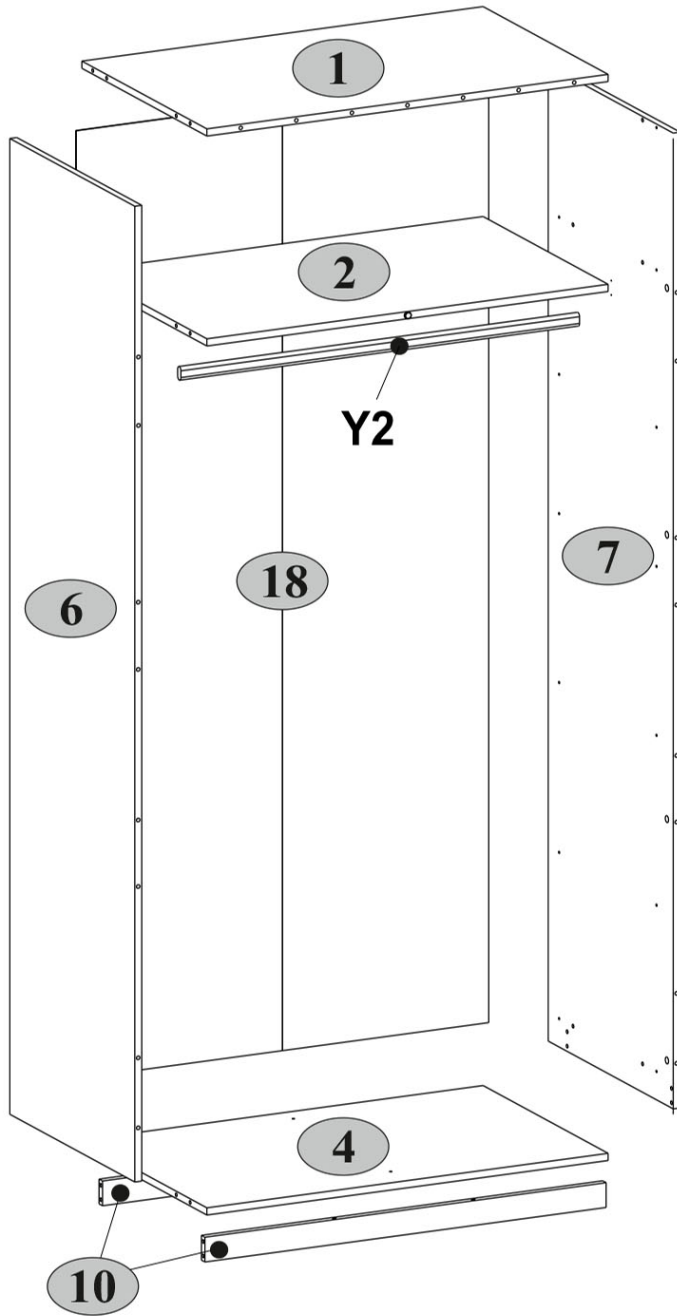
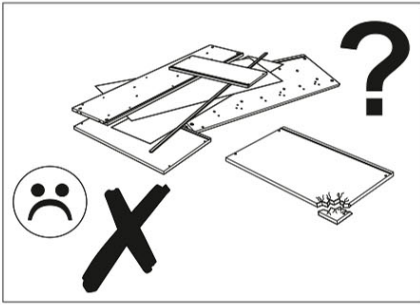

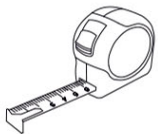
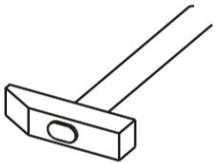
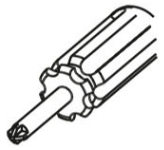
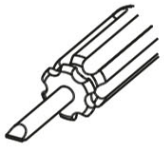
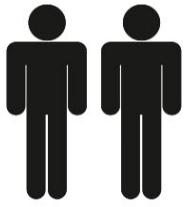



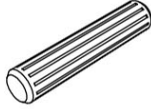
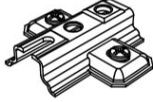
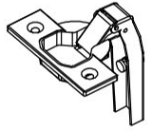
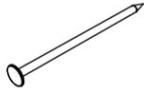

OPOZORILO! Padec kosa pohištva lahko zaradi zdrsa povzroči hude ali smrtne poškodbe. VEDNO pritrdite ta kos pohištva na steno z pritrdilnimi elementi. Za opečne in betonske stene se uporablja vgrajeni zatič. Za pritrditev na steno uporabite pritrdilne elemente, primerne za material stene; če niste prepričani, katera vrsta pritrdilnih elementov je primerna za material stene, se obrnite na strokovnjaka ali specializirano trgovino. Za pritrdilne elemente je na koncu odgovoren izvajalec montaže. Za dodatno zmanjšanje tveganja hudih telesnih poškodb in smrti zaradi padca pohištva:

- Najtežje predmete položite v spodnji predal.
- Težkih predmetov ne postavljajte na zgornji del predala.
- Nikoli ne dovolite otrokom, da plezajo po predalih, vratih ali policah.
- Pohištvo uporabljajte v skladu s predvidenim namenom





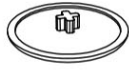
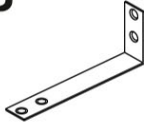



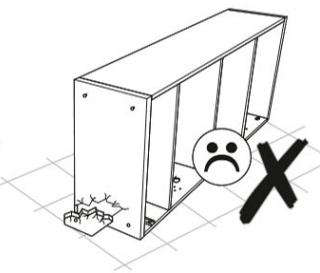
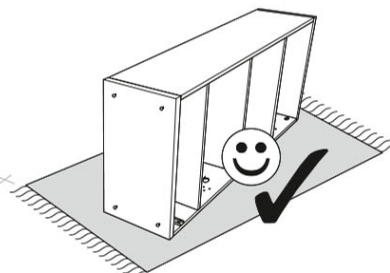
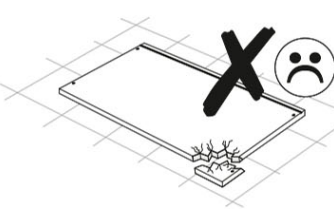
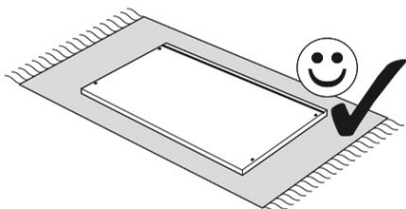
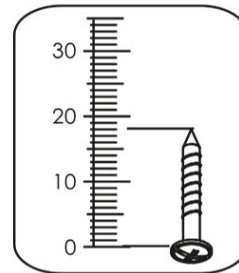
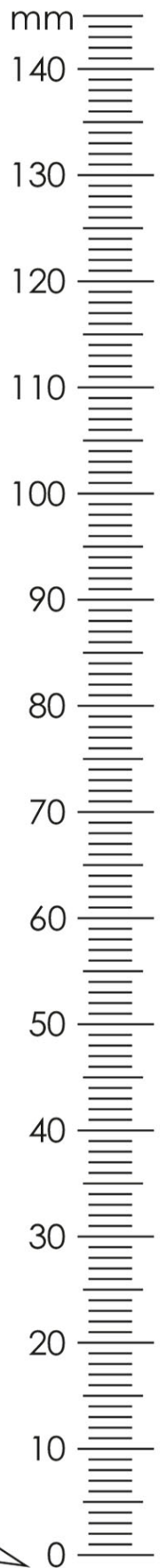

A1.0  5x28 24	A2  15x13 28	A9  L-47,4 2
B5  10x50 1	C1  8x35 39	D1  8
E2  8	G  1,5x26 38	H63  2
M4  M4x22 4	N1  8	Q  1,5x7 4
R5  3x30 4	R23  6,3x13 16	R102  3,5x16 22
S5  Ø18 20	U  130x35x15 1	V16  80x25x15 2
Y1  2		

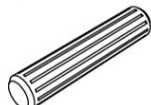

1

A1.0  5x28 12	A2  15x13 8	C1  8x35 8	R102  3,5x16 4	Y1  2
--	--	---	---	---

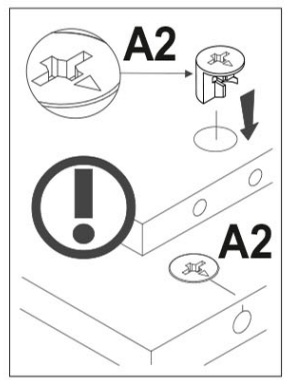
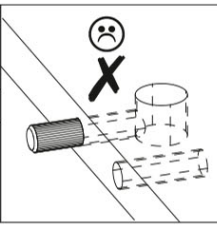
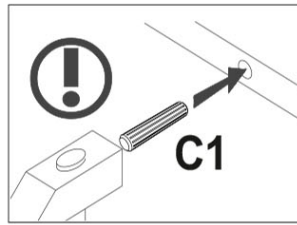
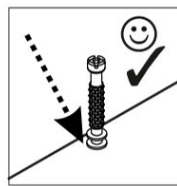
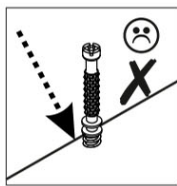
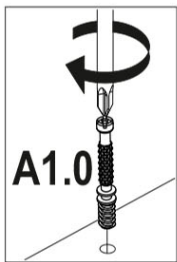
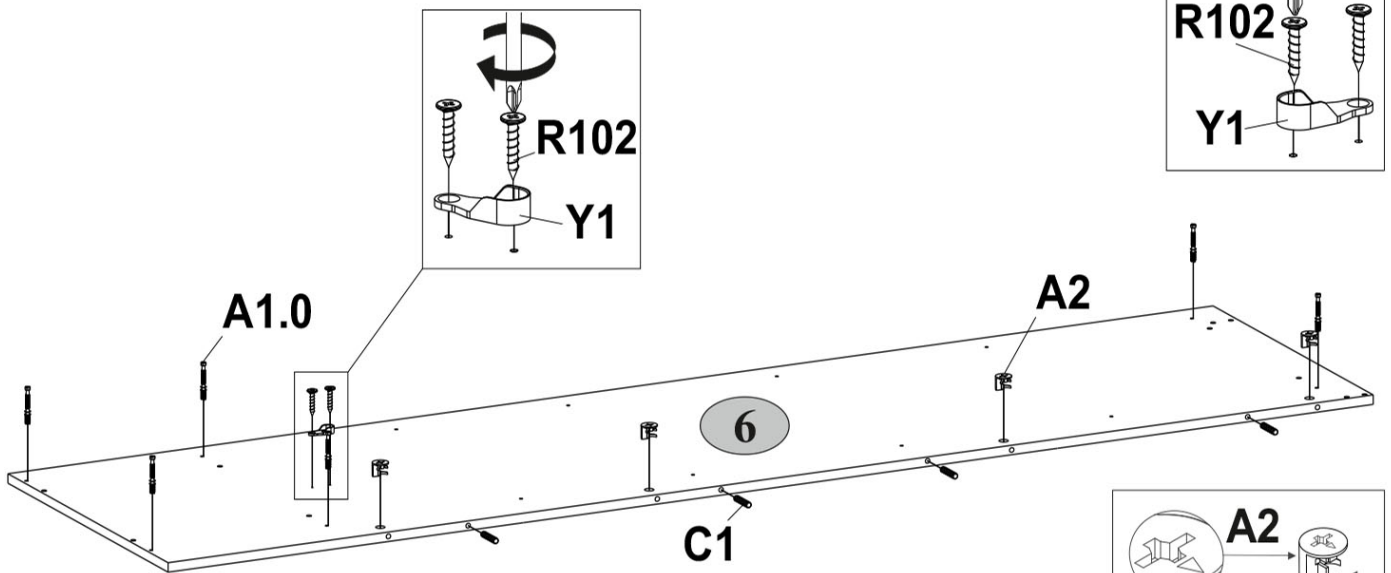
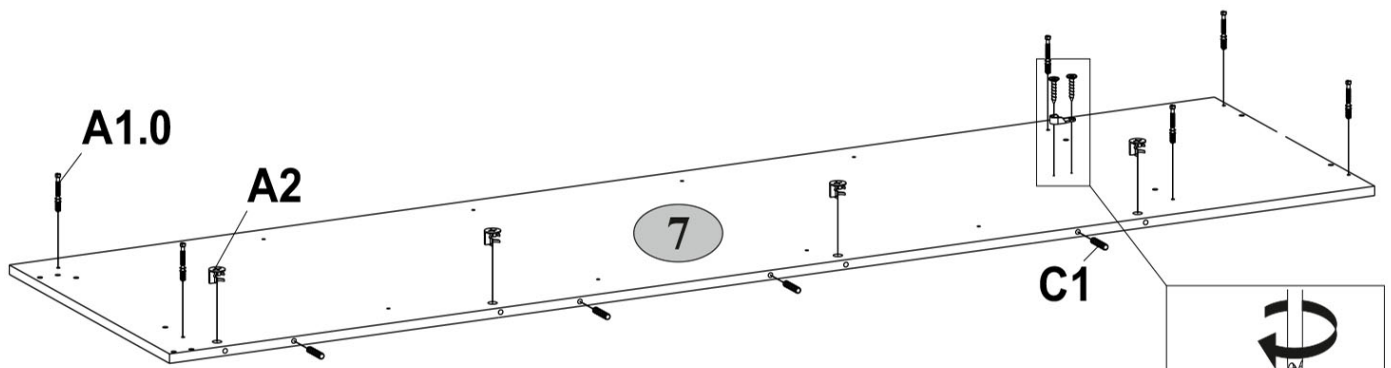

2

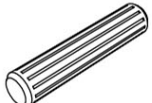
A2  15x13 8	C1  8x35 7
--	---

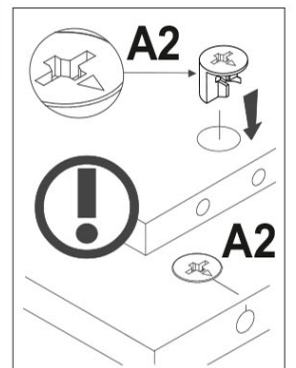
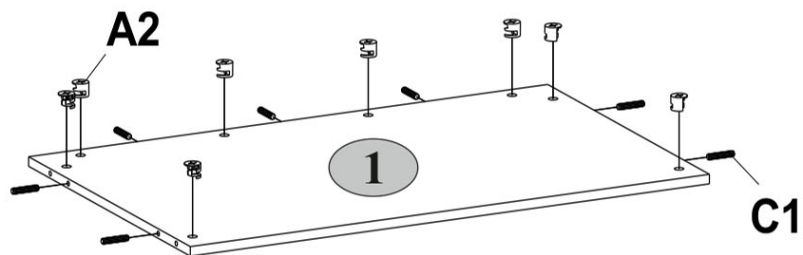
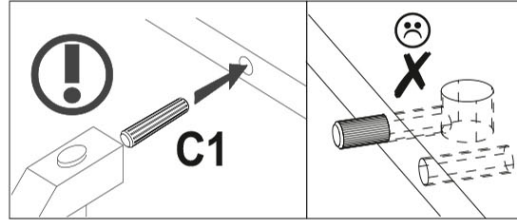

3

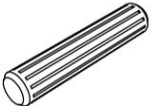
A2  15x13	C1  8 8x35 20
---	---

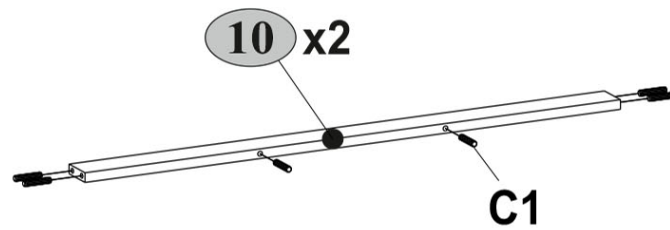
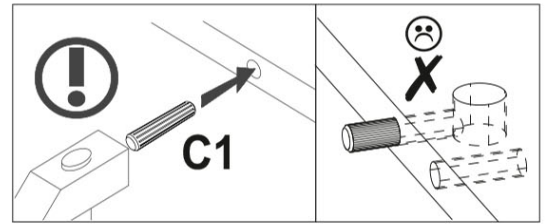
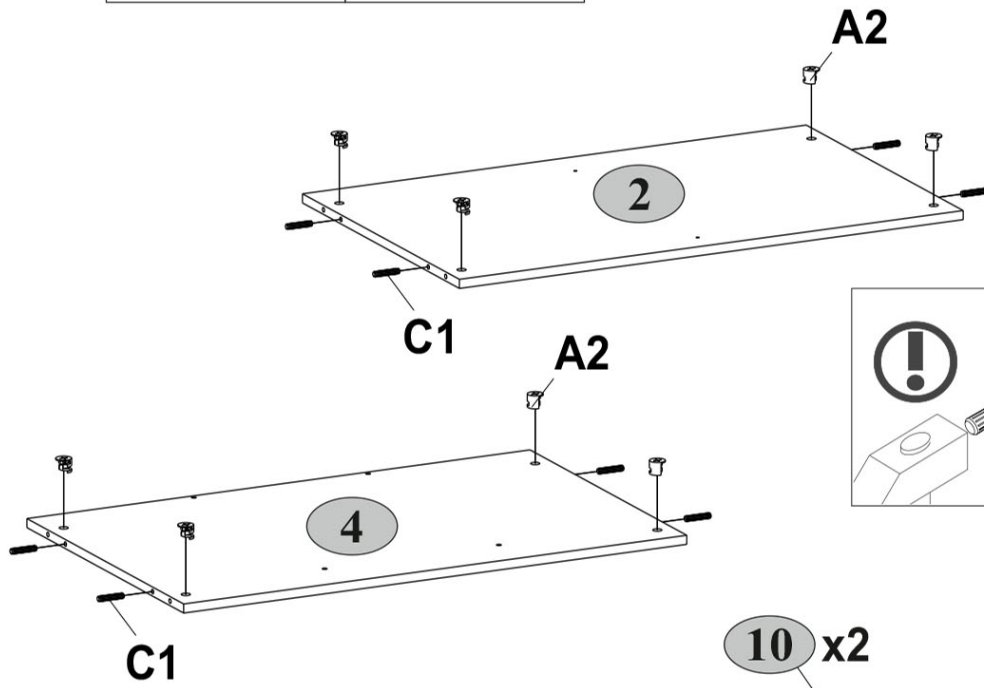
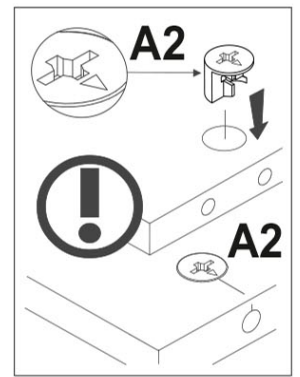

4

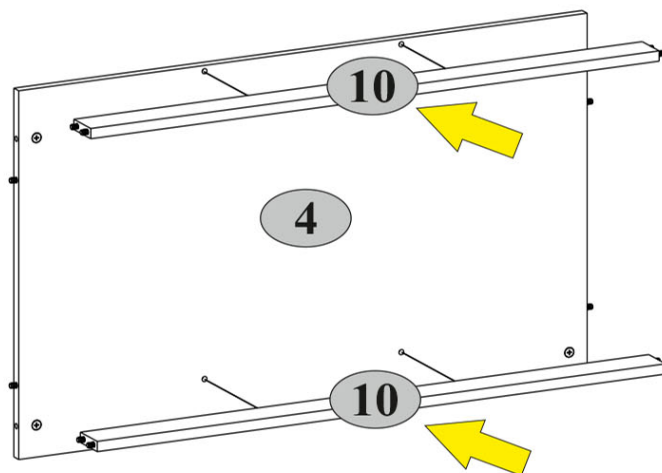



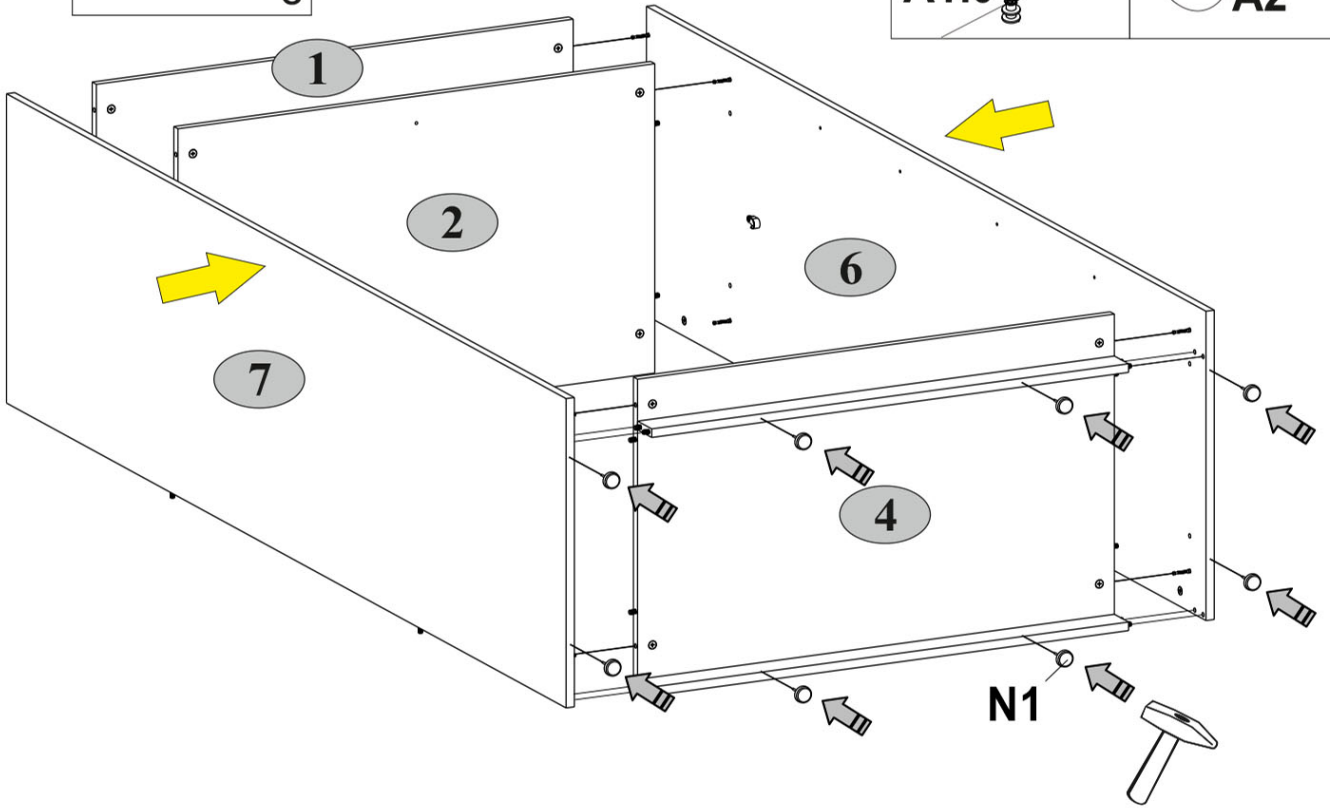
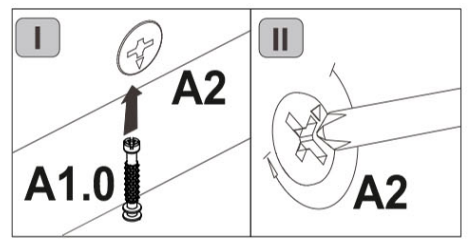
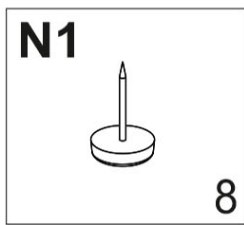

5

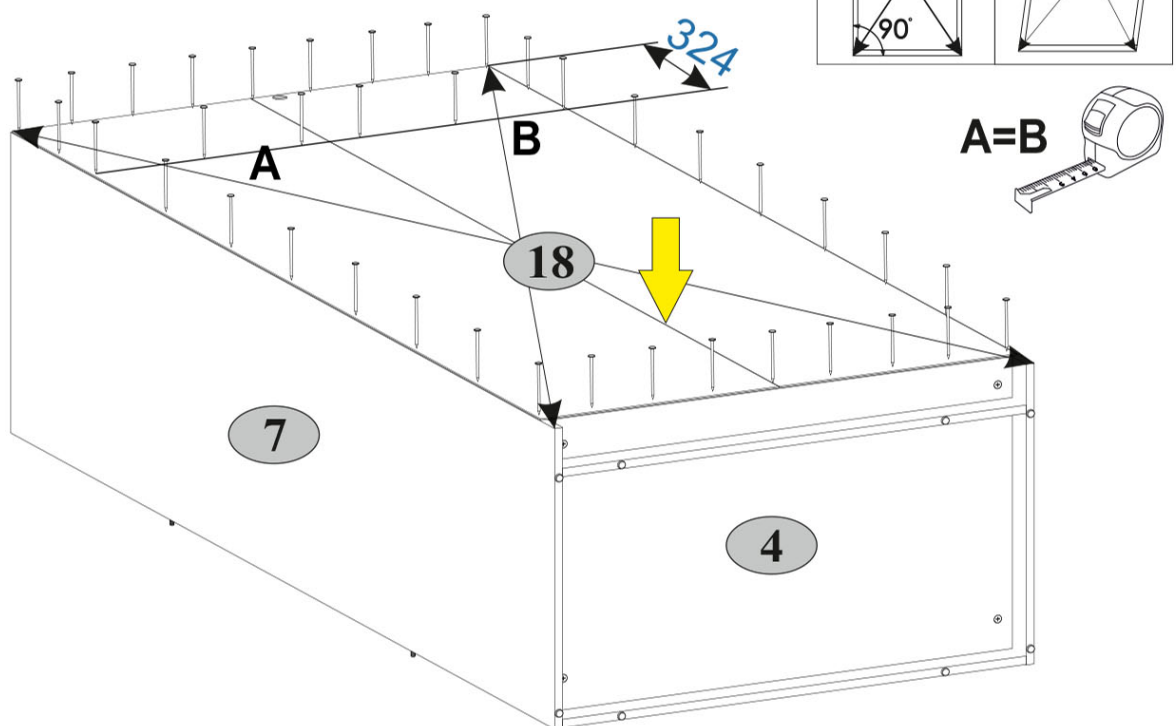
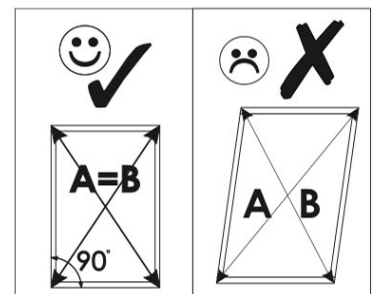
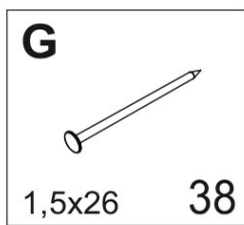

6

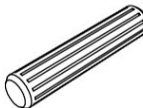
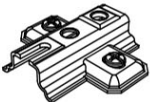

7

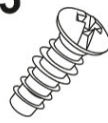
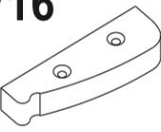
A1.0  5x28 12	A2  15x13 4	A9  L-47,4 2	C1  8x35 4	D1  8
R5  3x30 4	R23  6,3x13 16	V16  80x25x15 2		

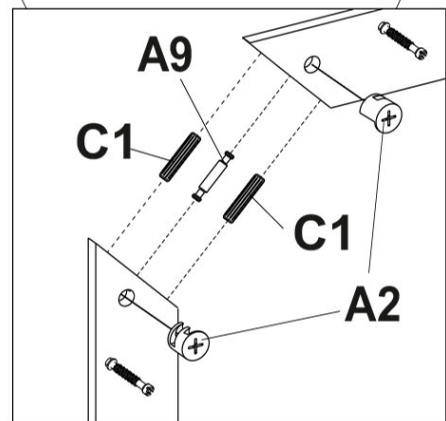
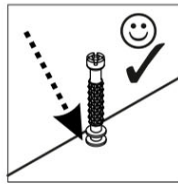
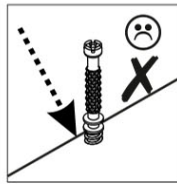
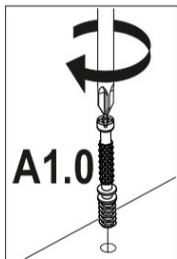
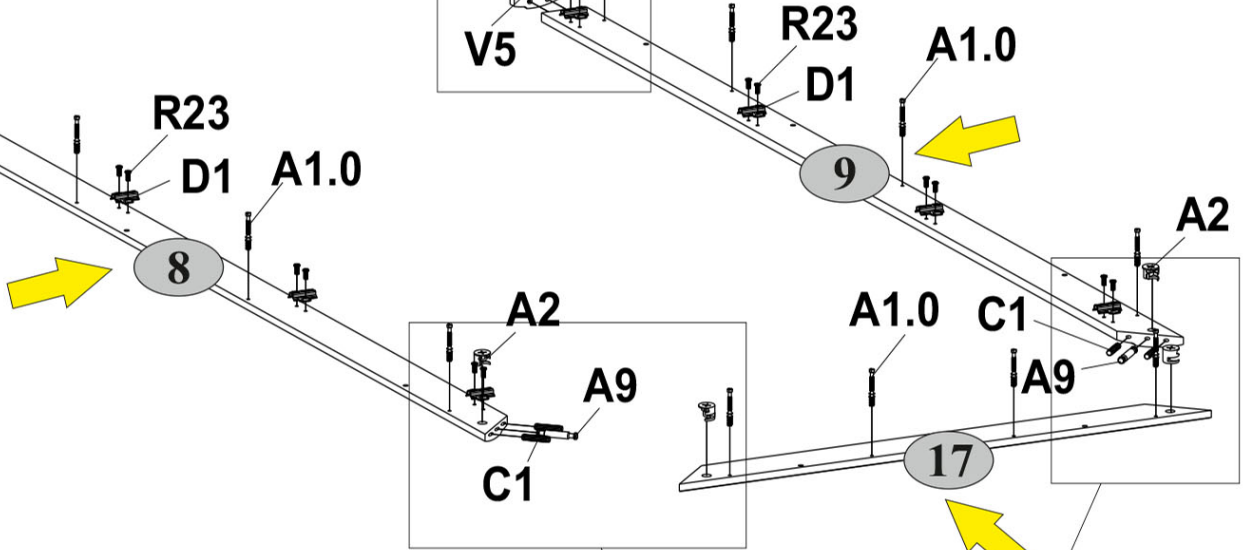
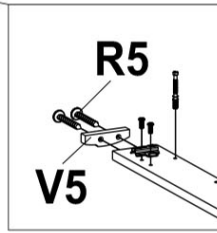
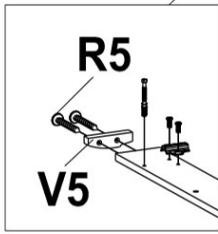
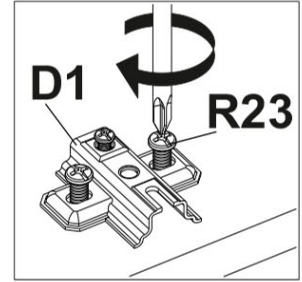
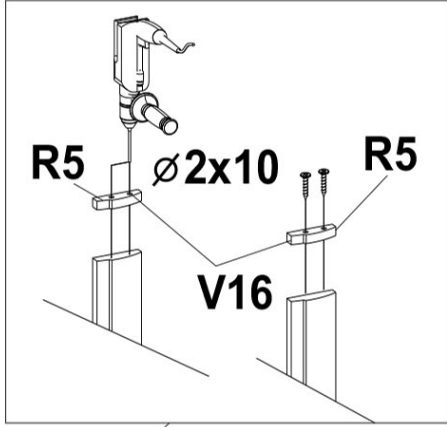

8

B5



10x50

1

U

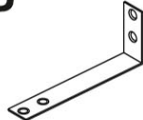

130x35x15

1

R102





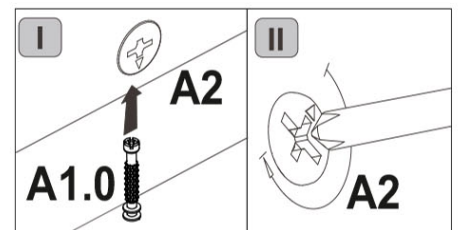
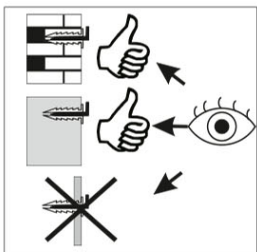
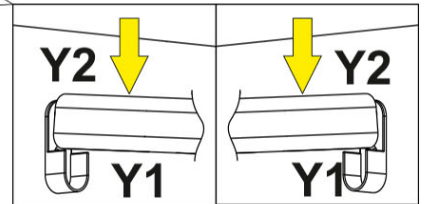
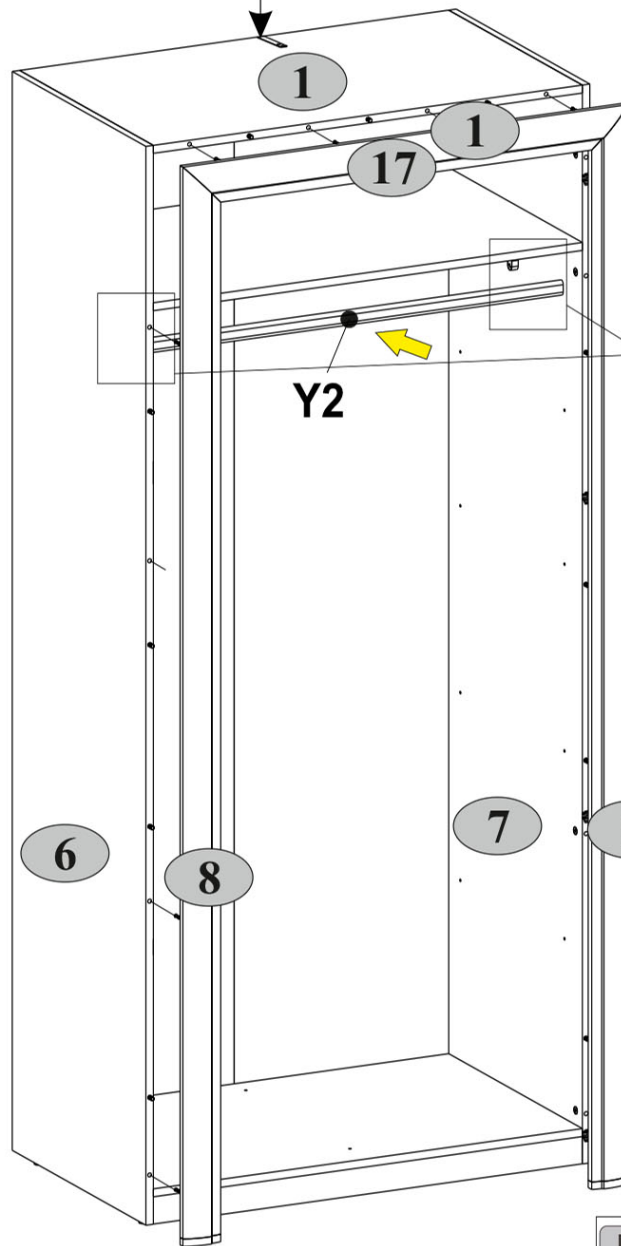
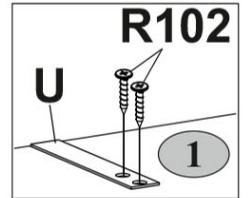
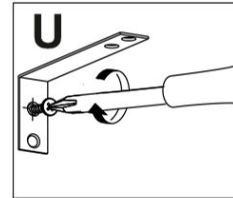
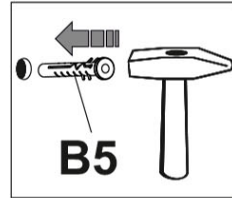
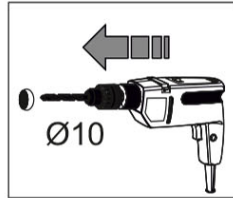
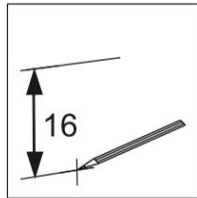
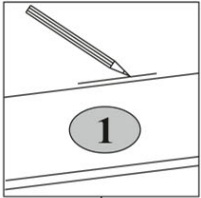
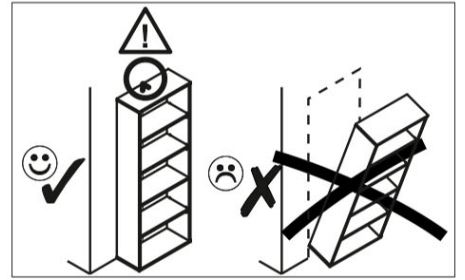

3,5x16

2

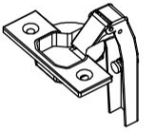



9

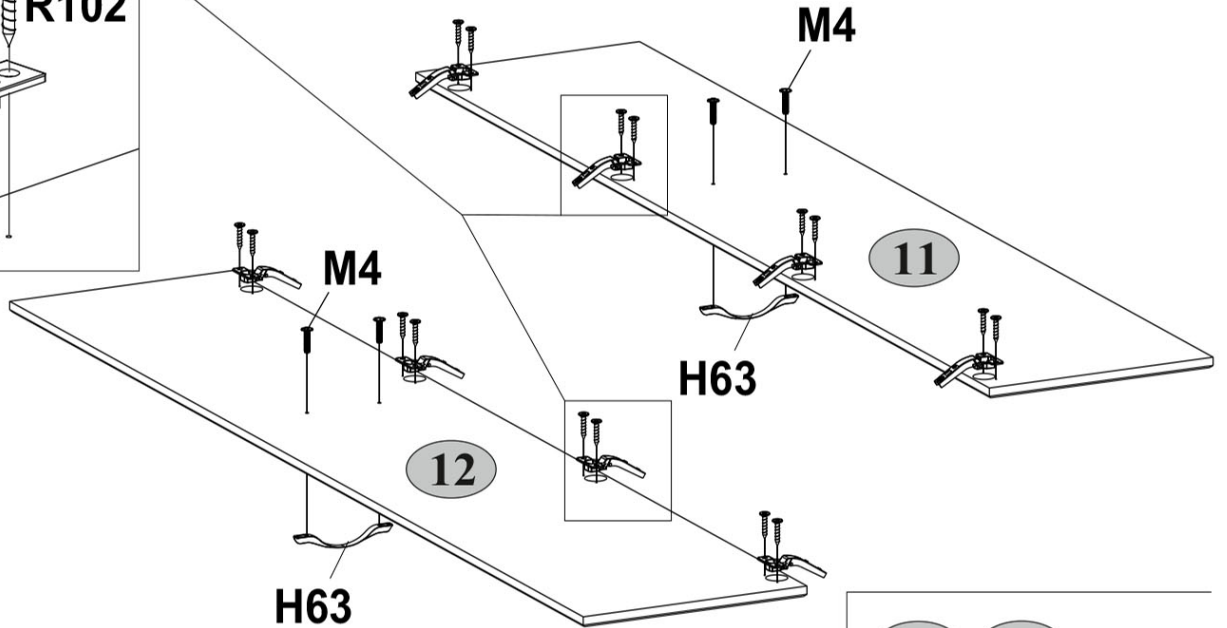
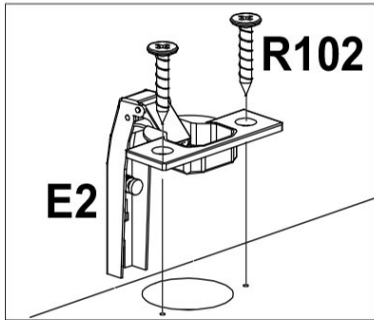

E2  8	H63  2	M4  M4x22 4	R102  3,5x16 16
---	--	---	---

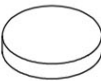

10

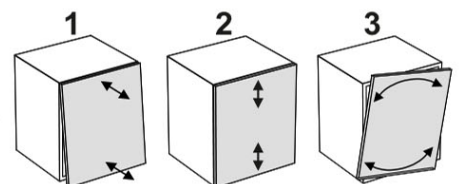
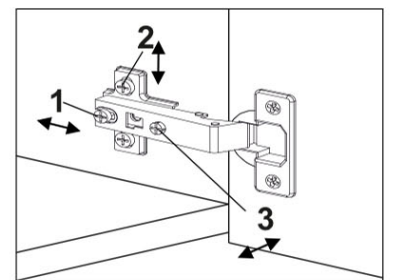
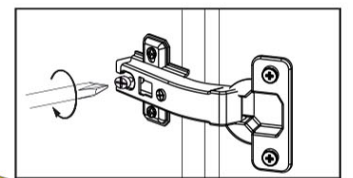
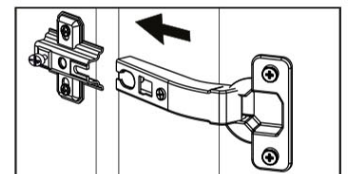
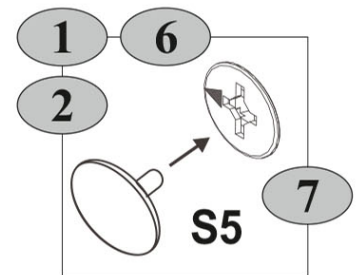
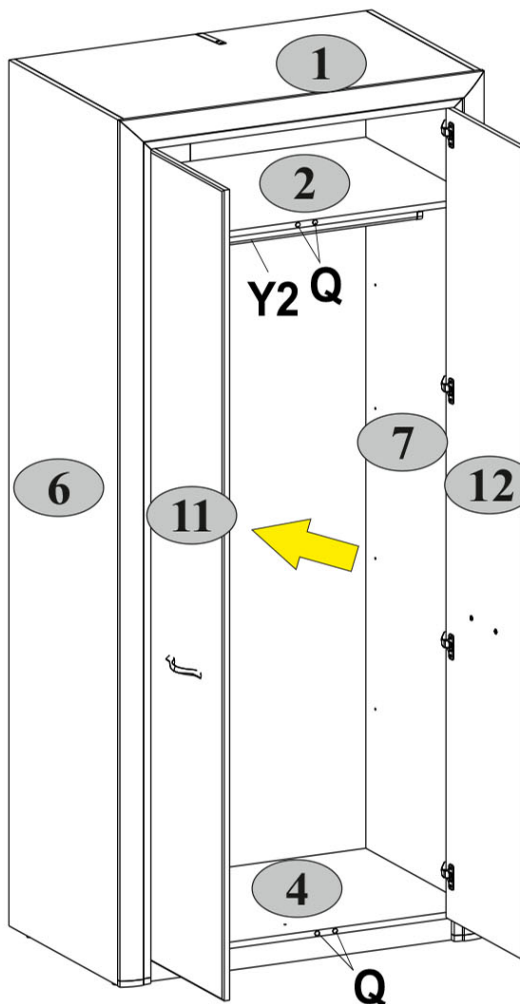
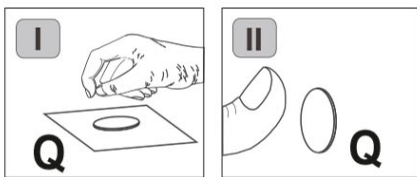
Q  1,5x7 4	S5  Ø18 20
--	--



- 1** **2**  max. 5 kg
- 4**  max. 10 kg
- Y2**  max. 15 kg